

Cycle stands.

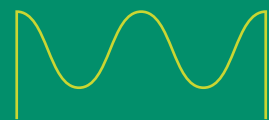

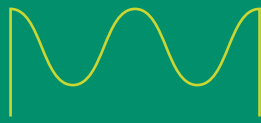

Cycle stands.

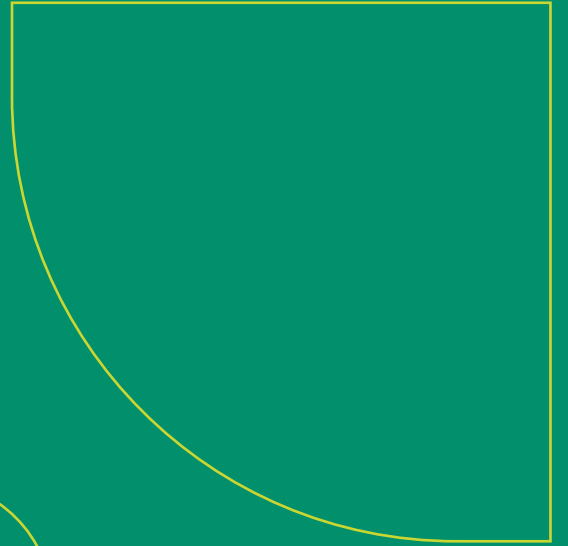
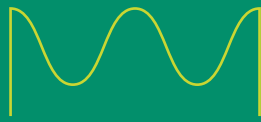
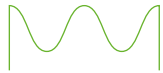
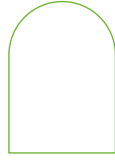

On your bike!

Cycling is the fastest growing mode of transport, as unlike cars, it is an environmentally friendly option for travel with zero-emissions. Ideal for reducing carbon footprint and improving air quality in local areas.

With its ever-growing popularity it is essential that local authorities, retail centres, workplaces, education establishments and leisure facilities provide increased, secure bicycle parking facilities.

Furnitubes' cycle stands range consists of simple, industry standard solutions to unique bold designs. No matter what your scheme, there's an option to

suit any environment and the option to customise with tape, branding, materials and finishes. All Stands and racks can be supplied for in-ground installation or bolt-down installation.

Browse our cycle parking range to find the best suited option for your scheme or business. Need help choosing? We offer no obligation professional advice to assist with your product selection.

Why choose a Furnitubes cycle stand?

- **Made in the UK** - low carbon emissions
- **Sustainable** - recycled steel for most of our steelwork
- **Easy to maintain** - hardwearing & high-quality products
- **Cost effective** - a cycle stand solution to suit all budgets

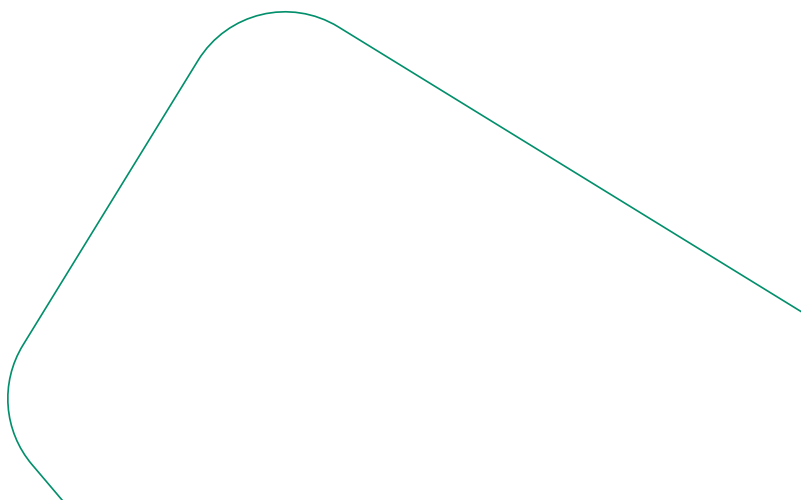
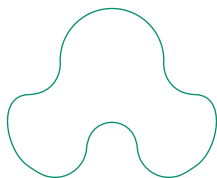

A cycle stand to suit every site.

Choice of materials & finishes

Mild steel in a choice of:

- Galvanised finish
- Polyamide coating

Stainless steel in grades 304 & 316 in a choice of

- Bright polished finish
- Satin polished finish

• Polyurethane elastomer (PU) in:

- Matt painted finish

Choice of options

Options:

- Add pre-fixed cycle parking signs or stickers
- Add reflective bands for improved visibility

Installation options

Root Fixed

- Foundation depth is usually the same as the root depth of the cycle stand
- Minimum recommended foundation square is 200mm
- Concrete mix to 25 newtons

Bolt-down

- Base plate on each upright, each with 2 no. Ø12mm ground fixing holes

Letterforms A-I.

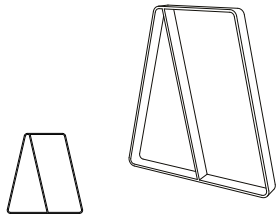

'A' LETTERFORM

705MM X 750MM
A/G X 300MM B/G

LET 650 A PM

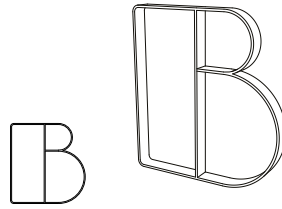

'B' LETTERFORM

700MM X 750MM
A/G X 300MM B/G

LET 650 B PM

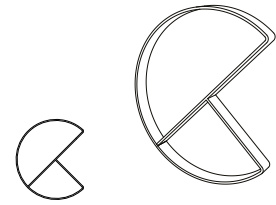

'C' LETTERFORM

630MM X 750MM
A/G X 300MM B/G

LET 650 C PM

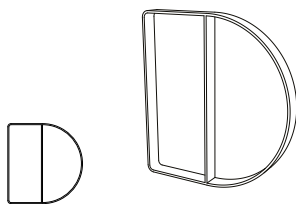

'D' LETTERFORM

700MM X 750MM
A/G X 300MM B/G

LET 650 D PM

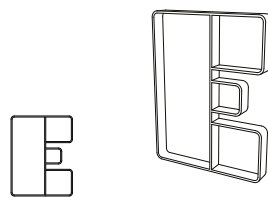

'E' LETTERFORM

575MM X 750MM
A/G X 300MM B/G

LET 650 E PM

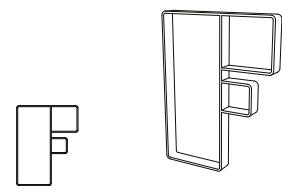

'F' LETTERFORM

575MM X 750MM
A/G X 300MM B/G

LET 650 F PM

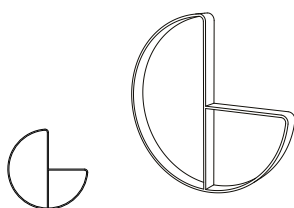

'G' LETTERFORM

750MM X 750MM
A/G X 300MM B/G

LET 650 G PM

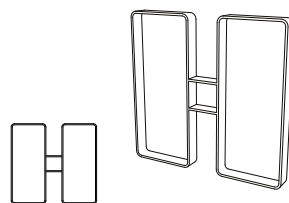

'H' LETTERFORM

800MM X 750MM
A/G X 300MM B/G

LET 650 H PM

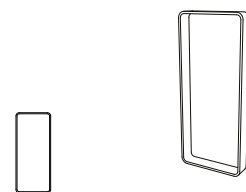

'I' LETTERFORM

375MM X 750MM
A/G X 300MM B/G

LET 650 I PM

Letterforms J-R.

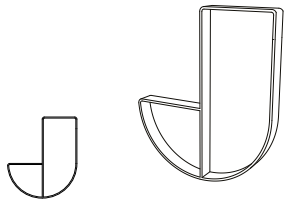

'J' LETTERFORM

650MM X 750MM
A/G X 300MM B/G

LET 650 J PM

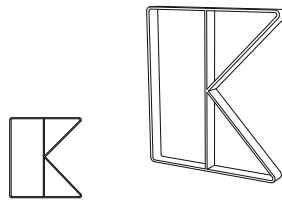

'K' LETTERFORM

675MM X 750MM
A/G X 300MM B/G

LET 650 K PM

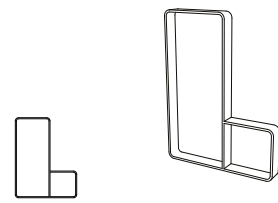

'L' LETTERFORM

575MM X 750MM
A/G X 300MM B/G

LET 650 L PM

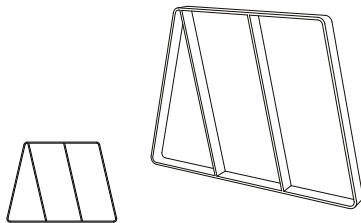

'M' LETTERFORM

1030MM X 750MM
A/G X 300MM B/G

LET 650 M PM

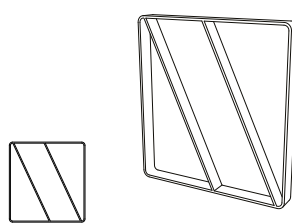

'N' LETTERFORM

710MM X 750MM
A/G X 300MM B/G

LET 650 N PM

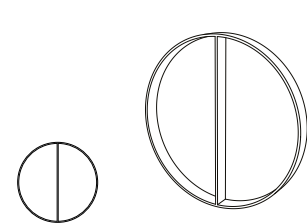

'O' LETTERFORM

750MM X 750MM
A/G X 300MM B/G

LET 650 O PM

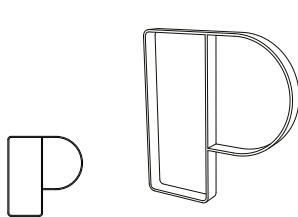

'P' LETTERFORM

700MM X 750MM
A/G X 300MM B/G

LET 650 P PM

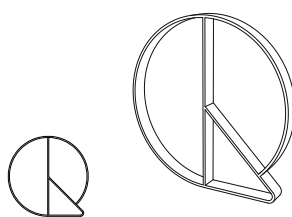

'Q' LETTERFORM

750MM X 750MM
A/G X 300MM B/G

LET 650 Q PM

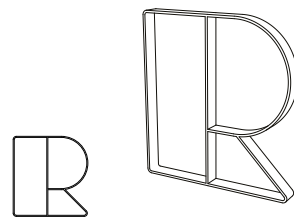

'R' LETTERFORM

700MM X 750MM
A/G X 300MM B/G

LET 650 R PM

Letterforms S-Z.

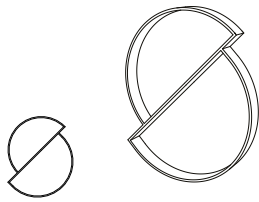

'S' LETTERFORM

610MM X 750MM
A/G X 300MM B/G

LET 650 S PM

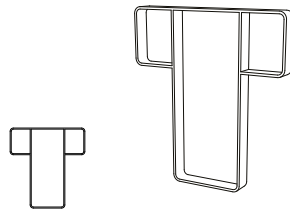

'T' LETTERFORM

700MM X 750MM
A/G X 300MM B/G

LET 650 T PM

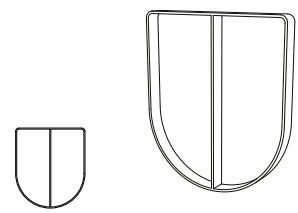

'U' LETTERFORM

650MM X 750MM
A/G X 300MM B/G

LET 650 U PM

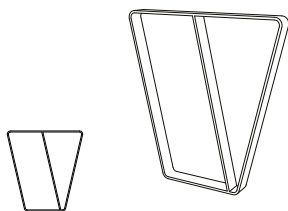

'V' LETTERFORM

705MM X 750MM
A/G X 300MM B/G

LET 650 V PM

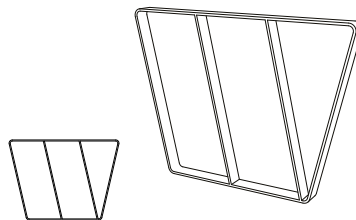

'W' LETTERFORM

1030MM X 750MM
A/G X 300MM B/G

LET 650 W PM

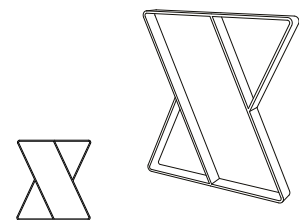

'X' LETTERFORM

685MM X 750MM
A/G X 300MM B/G

LET 650 X PM

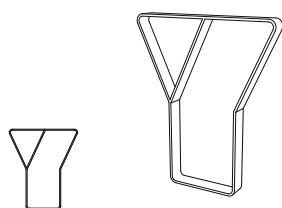

'Y' LETTERFORM

635MM X 750MM
A/G X 300MM B/G

LET 650 Y PM

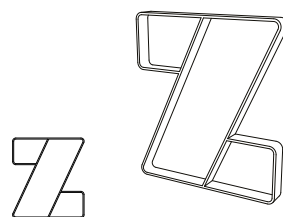

'Z' LETTERFORM

670MM X 750MM
A/G X 300MM B/G

LET 650 Z PM

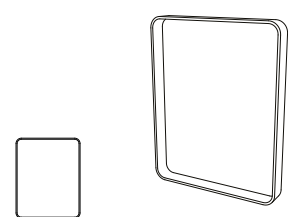

BLANK LETTERFORM

600MM X 750MM
A/G X 300MM B/G

LET 650 OO PM

Sheffield.

Simple & effective, the go to cycle stand

Sheffield has become the by-word for the cost-effective and proven range of hoopstyle cycle stands. Manufactured in robust circular section tube, the Sheffield range is offered in both mild steel and stainless steels (grades 304 & 316) and two widths, and all available as a rooted version for in-ground fixing or with a base plate for bolting down.

Further options include a taper rail designed to aid the visually impaired and reflective bands (available in a choice of colours for visual contrast with the stand metalwork) to improve the visibility of the products for night time motorists.

- Single stand or toast rack option
- Manufactured in our **Kent factory** from **recycled steel**
- Choice of **materials** and **finishes**
- **Bolt-down** or **in-ground** options
- Optional **tapper rail** and **reflective band**
- Stock item - **quick leads times**



Sheffield.

Options

Tapper Rail

Fully welded horizontal rail in same CHS as cycle stand hoop

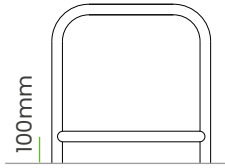

Reflective Tape

2 bands as shown, in various colour / relectivity grade options

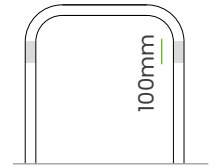

Root fixing

Tube ends crushed to aid embedment

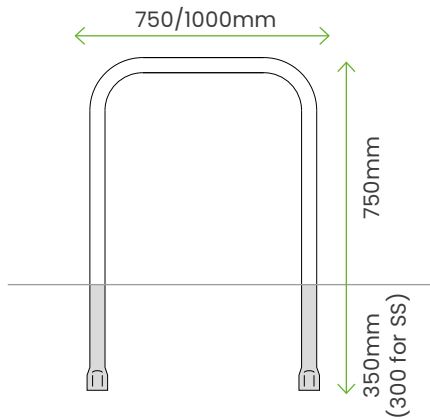

Ø48.3MM MILD STEEL

750MM X 750MM A/G

+ TAPPER RAIL

1000MM X 750MM A/G

+ TAPPER RAIL

GALVANISED

SHE6-7535-75-GA

SHE6-7535-75-TR-GA

SHE6-7535-10-GA

SHE6-7535-10-TR-GA

POLYAMIDE BLACK

SHE6-7535-75-PM

SHE6-7535-75-TR-PM

SHE6-7535-10-PM

SHE6-7535-10-TR-PM

Ø50.8MM G304 STAINLESS STEEL

750MM X 750MM A/G

+ TAPPER RAIL

1000MM X 750MM A/G

+ TAPPER RAIL

SATIN POLISHED

SHE6-7530-75-S4

SHE6-7530-75-TR-S4

SHE6-7530-10-S4

SHE6-7530-10-TR-S4

BRIGHT POLISHED

SHE6-7530-75-B4

SHE6-7530-75-TR-B4

SHE6-7530-10-B4

SHE6-7530-10-TR-B4

Ø50.8MM G316 STAINLESS STEEL

750MM X 750MM A/G

+TAPPER RAIL

1000MM X 750MM A/G

+ TAPPER RAIL

SHE6-7530-75-S6

SHE6-7530-75-TR-S6

SHE6-7530-10-S6

SHE6-7530-10-TR-S6

SHE6-7530-75-B6

SHE6-7530-75-TR-B6

SHE6-7530-10-B6

SHE6-7530-10-TR-B6

Base plate fixing

On each end, with 2 no. Ø14 holes in each plate

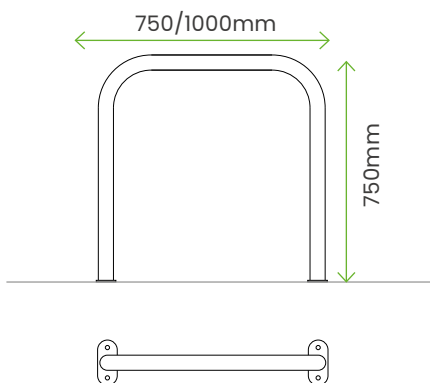

Ø48.3MM MILD STEEL

750MM X 750MM A/G

+ TAPPER RAIL

1000MM X 750MM A/G

+ TAPPER RAIL

GALVANISED

SHE6BASE-75-75-GA

SHE6BASE-75-75-TR-GA

SHE6BASE-75-10-GA

SHE6BASE-75-10-TR-GA

POLYAMIDE BLACK

SHE6BASE-75-75-PM

SHE6BASE-75-75-TR-PM

SHE6BASE-75-10-PM

SHE6BASE-75-10-TR-PM

Ø50.8MM G304 STAINLESS STEEL

750MM X 750MM A/G

+ TAPPER RAIL

1000MM X 750MM A/G

+ TAPPER RAIL

SATIN POLISHED

SHE6BASE-75-75-S4

SHE6BASE-75-75-TR-S4

SHE6BASE-75-10-S4

SHE6BASE-75-10-TR-S4

BRIGHT POLISHED

SHE6BASE-75-75-B4

SHE6BASE-75-75-TR-B4

SHE6BASE-75-10-B4

SHE6BASE-75-10-TR-B4

Ø50.8MM G316 STAINLESS STEEL

750MM X 750MM A/G

+TAPPER RAIL

1000MM X 750MM A/G

+ TAPPER RAIL

SHE6BASE-75-75-S6

SHE6BASE-75-75-TR-S6

SHE6BASE-75-10-S6

SHE6BASE-75-10-TR-S6

SHE6BASE-75-75-B6

SHE6BASE-75-75-TR-B6

SHE6BASE-75-10-B6

SHE6BASE-75-10-TR-B6

Fin.

Distinctive, durable design

The Fin cycle stand is a Furnitubes' original design - inspired by the profile of a shark's fin breaking the surface of the ocean. The combination of this distinctive form and heavy duty steel sections make the Fin a much more prominent site feature than other simpler hoop designs.

Material options include galvanised or plastic coated mild steel, or stainless steel in grades 304 or 316, in a satin or bright polished finish.

- Choice of **materials** and **finishes**
- Option for a **decorative corner** plate with hole
- With or without **tapper rail**
- Choose from **two tube sizes** - Ø48mm or Ø60mm
- **Bolt-down** or **in-ground** options
- Designed and made by us in the **UK**



Root Fixed versions

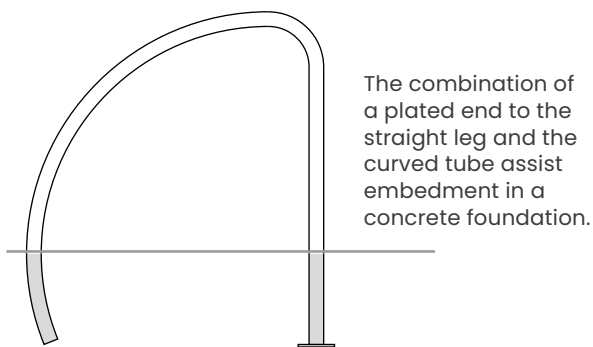

Bolt down versions

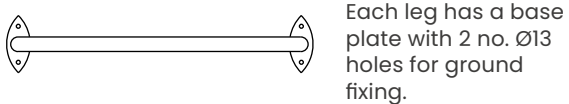

Corner plates, taper rail & reflective tape

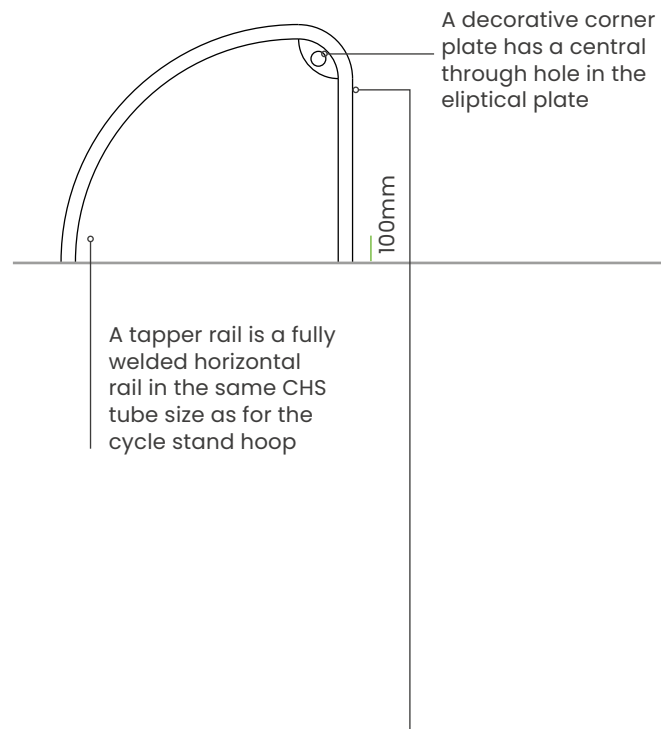

Ø48mm tube size Galvanised steel

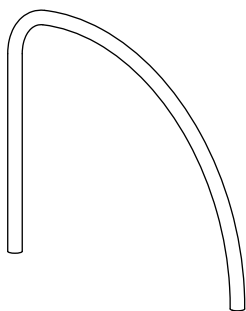

ROOT FIXED
980MM WIDE X 800MM A/G
X 300MM B/G

FIN480

BOLT DOWN
980MM WIDE X 800MM A/G

FIN480BASE

Ø60mm tube size Galvanised steel

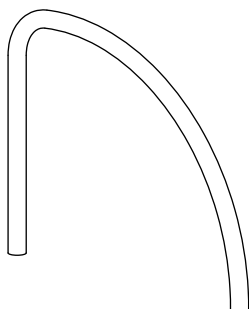

ROOT FIXED
1040MM WIDE X 800MM A/G X
300MM B/G

FIN600

BOLT DOWN
1040MM WIDE X 800MM A/G

FIN600BASE

Ribbon.

Elegant, harmonising cycle stands

The elegant delta-shape of Ribbon cycle stand is derived from end profiles of the seating from the same range. Two cycle stands are offered as part of the range - a short version to exactly match the profile of the standard Ribbon bench support, a larger model of more conventional cycle stand scale, all stands are manufactured from 10mm thick solid flat bar section, complete with a standard taper bar to assist the visually impaired.

- Part of a **coordinated suite of seating products**
- Choose steel **polyamide** finish or **stainless steel**
- Available in a **choice of two size options**
- **Bolt-down** or **in-ground** options



Root Fixed versions

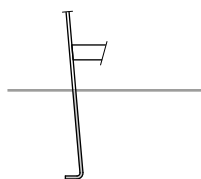

Uprights extend 300mm below ground, with a returned end to aid embedment in concrete.

Bolt down versions

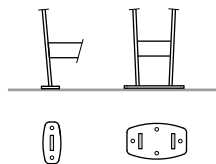

RIB 515 & 750 have a base plate on each upright & RIB 195 has a single plate. Fixing holes are Ø12.

Steel, black polyamide finish Root Fixed

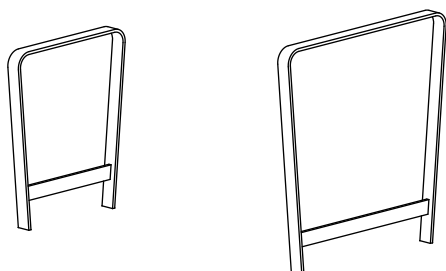

515MM X 625MM A/G X 300MM B/G

RIB515

750MM X 800MM A/G X 300MM B/G

RIB750

Coordinate your scheme with Ribbon seating.

For a fully coordinated suite we have the slick and stylish Ribbon seating range. Based on a minimal number of seat support components and timber section profiles Ribbon and Ribbon XL can be

combined to give many different bench and seat assembly types.

The standard Ribbon range consists of these coordinating products:

Ribbon Seat



Ribbon Bench



Ribbon Multi Seat



Ribbon XL Seat



Ribbon XL Bench



Ribbon XL Recliner



Transport.

Functional bike parking

The Transport range of cycle stands incorporate a wide taper plate with integral cycle and parking logos. The range is available in polyurethane elastomer (PU) coated steel as standard, with galvanised. Polyurethane is durable material able to withstand the rigours of the outdoors as well as damage caused by cycle chains. In addition to providing an extra point to secure bicycles, the taper plate aids detection by the partially sighted.

- Available in **PU**
- Optional **tapper rail**
- Optional **parking logos** and **reflective tape**
- **Bolt-down** or **in-ground** options
- Made in the **UK**



Polyurethane Root Fixed

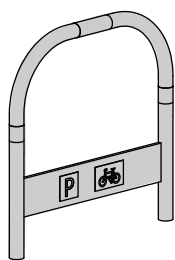

Ø50MM ELASTOMER COATING OVER GALVANISED STEEL CORE, PAINTED BLACK WITH VINYL LOGOS 750MM X 760MM A/G X 300MM B/G

TRL 600 PU

Morden.

Wavy M-shape stand

Two key features of the The Morden cycle stand are, it provides cyclists with multiple locking points for their bicycle and also is its contrasting visibility bands found on either side of the stand. It is available with a taper rail, which are generally required on individually-placed items or on the start / end of multi-stand groups.

- Optional **reflective bands & reflective tape** in a choice of colours
- Choice of **materials** and **finishes**
- Optional **tapper rail**
- **Bolt-down** or **in-ground** options
- Made in the **UK**



Root Fixed versions

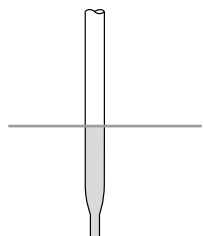

Crimped tube end aids embedment in concrete foundation

Bolt down versions

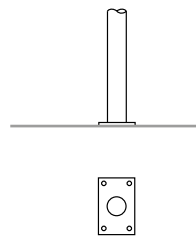

Base plate with 4 no. Ø10 holes for ground fixing

Ø48mm Steel, black polyamide Root Fixed

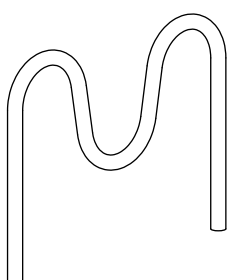

STAINLESS STEEL - BRIGHT POLISHED G304 / G316

STAINLESS STEEL - SATIN POLISHED G304 / G316

1000MM X 750MM A/G X 300MM B/G MOR 750 PM

1000MM X 750MM A/G X 300MM B/G WITH TAPPER RAIL MOR 750 TP

Nordic.

Loop-de-loop style stand

The Nordic steel cycle stand is a playful addition to any site, whilst also serving as a very effective cycle stand on account of its multiple locking points. Nordic is available in 3 sizes - with two, three or four looped crests - and are offered in Ø48mm steel in a galvanised, plastic coated or polyamide finish, or in stainless steel with a bright or satin polished finish.

- Available in **PU, steel or stainless steel**
- Choice of **finishes**
- **Fully-welded one piece fabrication**
- **Bolt-down** or **in-ground** options
- Made in the **UK**



Root Fixed versions

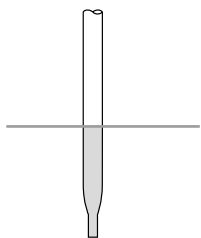

Crimped tube end aids embedment in concrete foundation

Bolt down versions

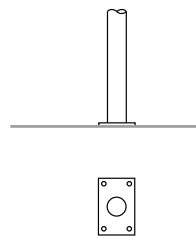

Base plate with 4 no. Ø10 holes for ground fixing

2-loop Ø48mm stainless steel, satin root fixed

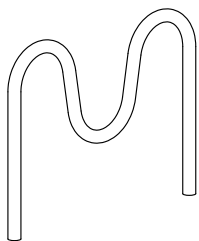

3-loop Ø48mm black polyamide steel, root fixed

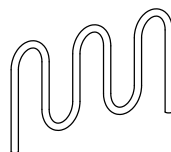

4-loop Ø48mm stainless steel, root fixed

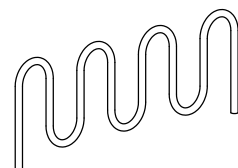

**945MM X 760MM A/G
X 350MM B/G**

NOR 302 S4

**1550MM X 760MM A/G
X 350MM B/G**

NOR 303 PM

**2150MM X 760MM A/G
X 350MM B/G**

NOR 304 S4

Omega.

Spherical secure stand

The Omega cycle stand makes for a distinctive streetscape feature whilst also providing user-friendly multiple locking points, suitable for securing all types of cycle to. Manufactured from heavy duty recycled steel - with a tough black polyamide coating, or stainless steel grades 304 or 316, in a bright or satin polished finish.

- Available in **PU, steel or stainless steel**
- Choice of **finishes**
- **Fully-welded one piece fabrication**
- **Bolt-down** or **in-ground** options
- Made in the **UK**



Ø48mm Steel, black polyamide Root Fixed versions

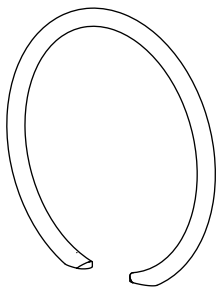

2 no. base plates
with 2 no. Ø14 holes

940MM X 860MM A/G X 300MM B/G

HOM 694 PM

Ø48mm Stainless steel, G304 Bolt down versions

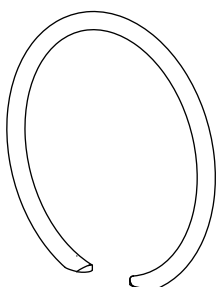

2 no. base plates
with 2 no. Ø14 holes

940MM X 860MM A/G

HOM 694 S4

District.

Heavy-duty hoop stand

The District cycle stand is constructed from steel with a black polyamide finish, or stainless steel with a satin or bright finish. The District root fixed cycle stand has a robust $\text{Ø}48\text{mm}$ tube.



- Available in **PU, steel or stainless steel**
- 3 **standard sizes** available
- Choice of **finishes**
- **Fully-welded one piece fabrication**
- **Bolt-down** or **in-ground** options
- Made in the **UK**

Root Fixed versions

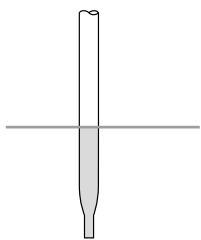

Crimped tube end aids embedment in concrete foundation

Bolt down versions

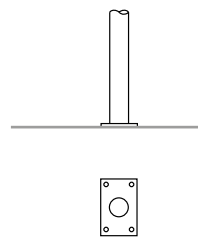

Base plate with 4 no. $\text{Ø}10$ holes for ground fixing

$\text{Ø}48\text{mm}$ Root Fixed

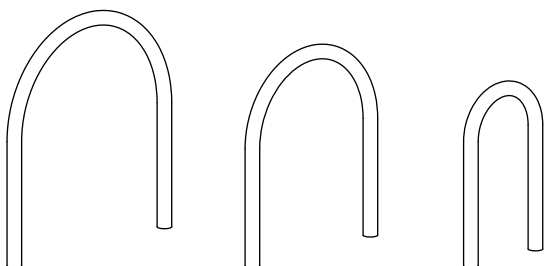

STAINLESS STEEL SATIN POLISHED,
360MM X 600MM A/G X 300MM B/G

DST 350 S

STAINLESS STEEL SATIN POLISHED,
600MM X 700MM A/G X 300MM B/G

DST 600 S

STAINLESS STEEL SATIN POLISHED,
750MM X 800MM A/G X 300MM B/G

DST 750 S

Hammersmith.

Heavy-duty hoop stand

Manufactured from extremely durable polyurethane elastomer (PU) material, the Hammersmith cycle stand is formed around a strong steel inner core, with a matt black finish. Suitable for the visually impaired and complying with DDA guidelines.

This stand is ideal for environments that require high strength bicycle parking with minimal to no maintenance.

- Available in **PU** or **steel**
- Choice of **finishes**
- **Bolt-down** or **in-ground** options
- Made by in the **UK**



Root Fixed versions

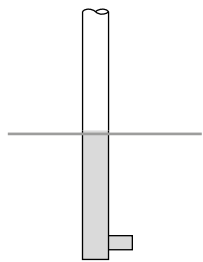

Inward facing plate on each leg aids embedment in concrete foundation

Bolt down versions

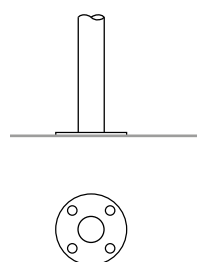

Base plate with 4 no. Ø20 holes for ground fixing

Polyurethane elastomer coating over galvanised steel core, painted matt black

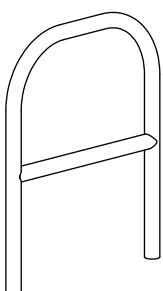

Ø55MM, ROOT FIXED
700MM X 875MM A/G X 300MM B/G

HAM700

Why Furnitubes.

- **Made in the UK**
our factory is based in Kent, so expect faster leadtimes and no supply chain delays
- **Easy to maintain + low labour costs**
we make sure that fixing points are easily accessible so slats and brackets can be changed easily when damaged
- **Modular solutions**
our ranges are modular and customisable, seating and planters can be easily combined, be creative without blowing the budget
- **Our approach**
we take a considered approach to design, it's not just about the end product. We take everything in the process into consideration, we are collaborative and we are committed to producing products that improve our environment & keep people safe.



Our Process.

- **Get in touch** – it's as simple as that, give us a call or drop us an email, we're happy to help whatever the medium!
- **Collaborate** – Depending on your needs, you might not actually need us at this stage, that's the beauty of our modular ranges – they're designed with you in mind, so you can specify with ease. Nevertheless, we are here for you if you do – our design team are always on hand to discuss the nitty gritty of your project.
- **Specification** – This is where our team of experts take the wheel and help you with sketches, CADs and more to help you specify our products as easily as possible.
- **Production + delivery** – all of our products are designed and manufactured in the UK allowing us to give you shorter lead times. With a dedicated project manager keeping you in the loop, you can trust everything is in hand.

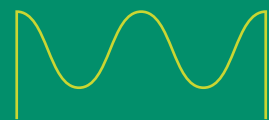
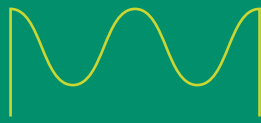
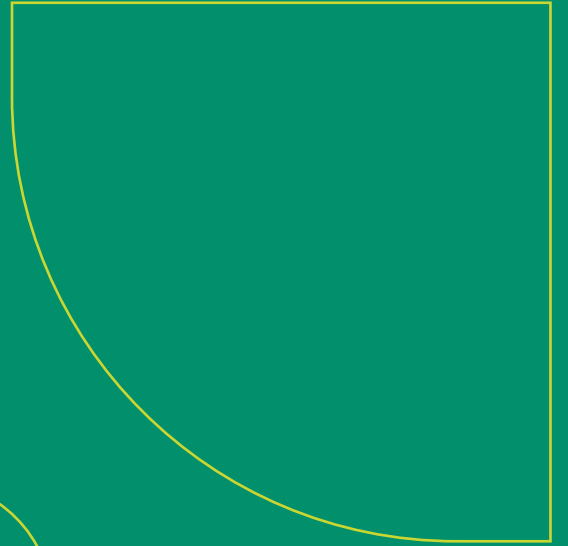
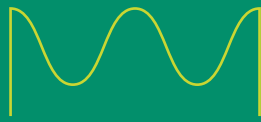



Furnitubes



Furnitubes



Furnitubes International UK

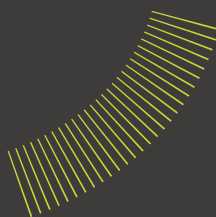

furnitubes
shaping outdoor spaces

T: +44 (0)20 8378 3200
E: sales@furnitubes.com
www.furnitubes.com